

THERMOSTATIC RAINFALL WATERFALL PHONE CONTROLLED SHOWER SYSTEM WITH SOUND SYSTEM AND HANDHELD SHOWER SPECIFICATIONS

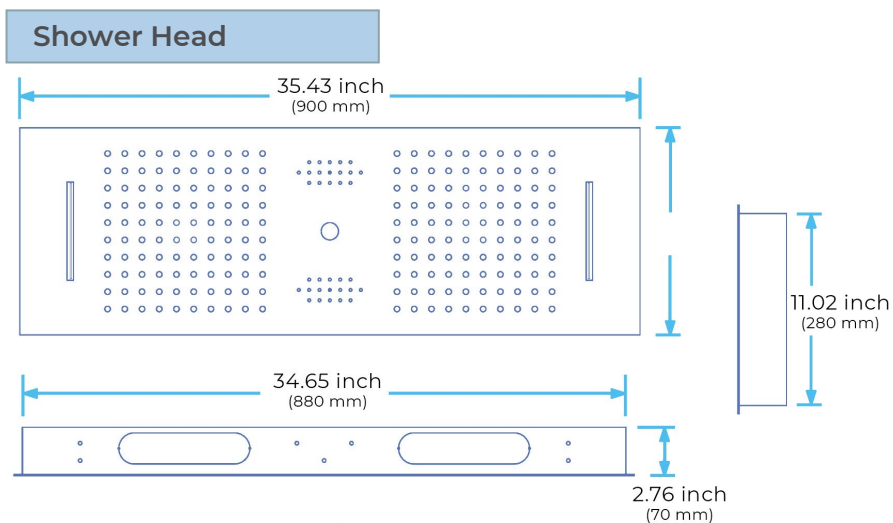

- Shower Panel /Hose Material: 304 Stainless Steel
- Shower Head Size: 900*300 mm
- Shower Mixer Material: Brass
- Concealed Mixer Size: 465*130 mm
- Showerheads Install: Embedded Ceiling Mounted
- Concealed Mixer Install: Wall-Mounted
- LED Shower Head Functions: Rainfall, Waterfall, Water Column
- Water Pressure: 0.3 MPA
- Water Flow: 16L/min~28L/min
- Hand Shower/ Shower holder Material: Brass
- Shower Accessories Material: Brass
- LED Light: Need to Connect Power
- LED Light Color: 64 Color
- Shower Hose Length: 1.5M
- AC: 100-265V 50/60Hz

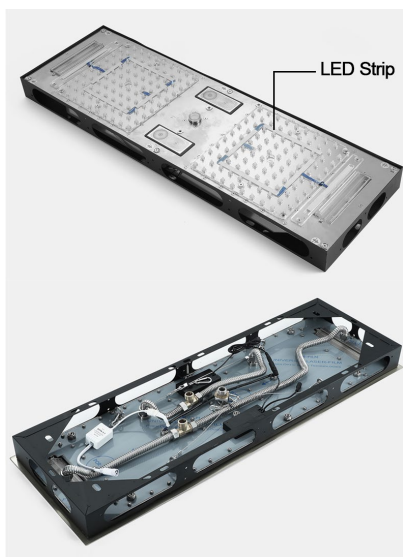
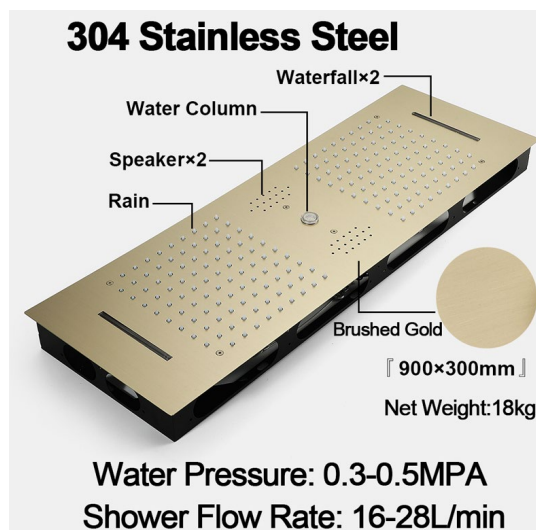

Kinds of color **64** temperature adjustable

WiFi

Build-in WIFI

Phone control color

Color software App install instruction

download name: Smart Life

All dimensions and specifications are nominal and may vary. Use actual products for accuracy in critical situations.

Shower Mixer

All functions can be used at the same time.

Spin button change water flow size.

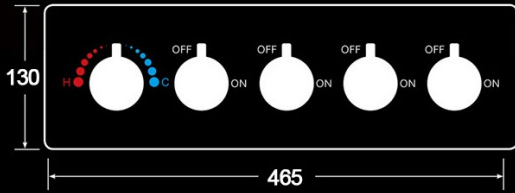

Thread have G 1/2" and NPT 1/2"

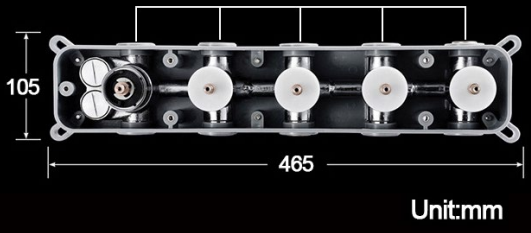

Spout

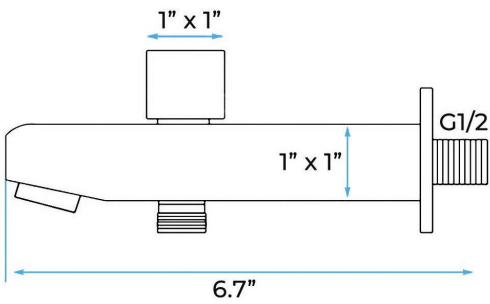

Hand Shower

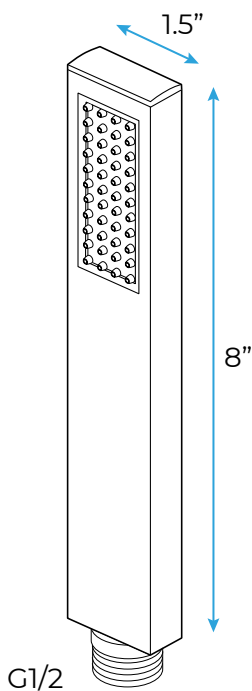

Flow Rate: 2.0 GPM / 7.6 LPM



38°C

Thermostatic Control

Main body
Brass casting body

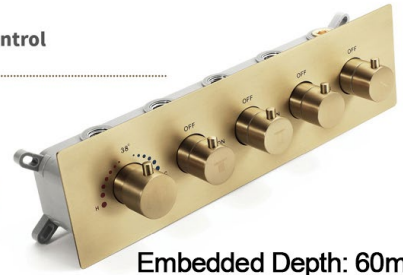

Brushed gold



Shower Mixer Connections

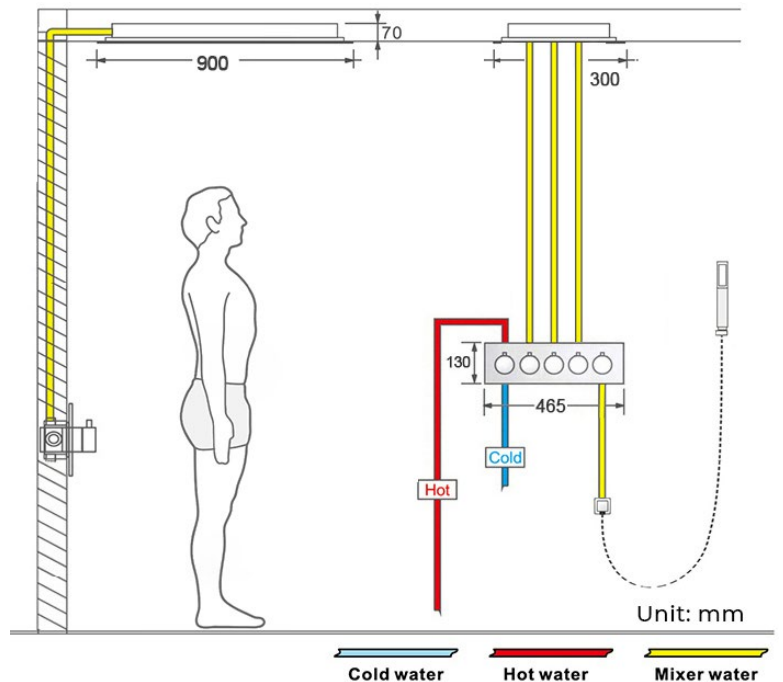

Cold water Hot water Mixer water